

# easycraft

## Decorative Wall & Ceiling Linings

### DIY - HOW TO SERIES

#### Finishing Options



#### Products to compliment & finish Easycraft Wall and Ceiling panels

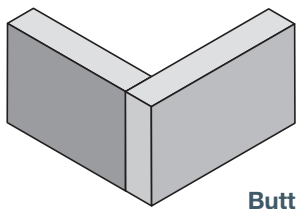

Butt

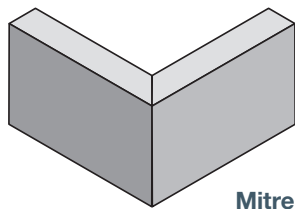

Mitre

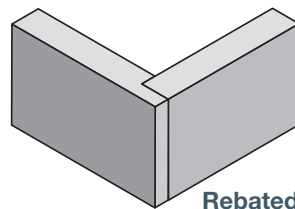

Rebated

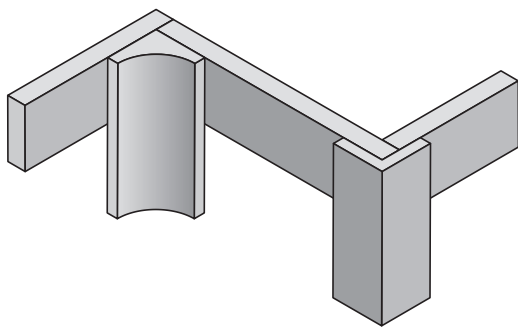

Internal and external corner moulding

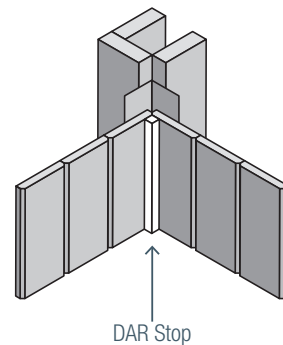

Internal and external corners using DAR Stops

Below are some examples of product found in your local Reseller that may compliment and provide options in finishing off your Easycraft panel project. **Note: Easycraft supply 2 dado rails that suit our dado size panels (rebated) and full wall size panels (flat).**

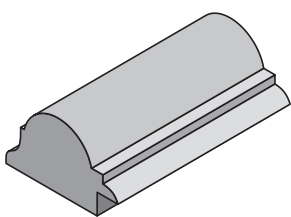

easydado - Rebated

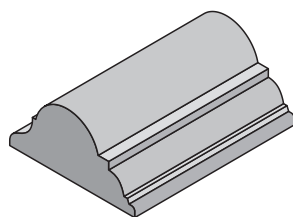

easydado - Flat

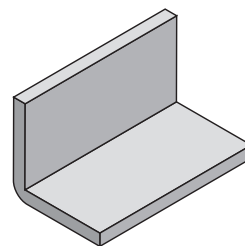

External Corner

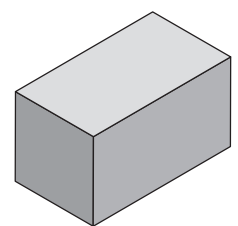

Stops DAR

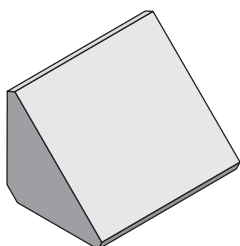

Tri-Quad Corner Moulding

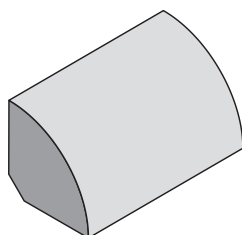

Quad Corner Moulding

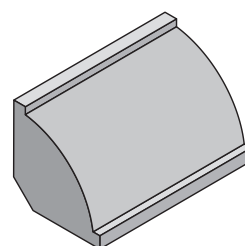

Ovolo Corner Moulding

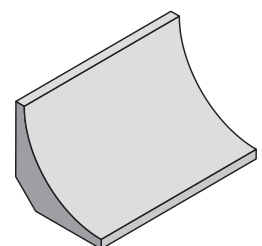

Scotia Corner Moulding